

ISEO è con
SAFETAL
il portale della sicurezza



Push-Tronic e Trim-Tronic.
La sicurezza intelligente è quella capace di dialogare.
IDEA:



Bolt e Push-Bolt.
Un'idea tira l'altra. (E quelle Iseo sono tutte buone).
IDEA:



Bolt
Chiusura brevettata per porte complanari e a sormonto.
IDEA:



Belvedere.
Accessori per montaggio di maniglioni antipanico su porte a vetro.
IDEA:

Maniglioni antipanico da cambiare!
6 anni di tempo per adeguare tutti gli immobili pubblici in base alla norma UNI EN 1125

ISEO







CSF.
Dalla combinazione infinita nasce la sicurezza assoluta.
GERA.

FIAM
serrature

COMPANY
WITH QUALITY SYSTEM
CERTIFIED BY DNV
=ISO 9001/2000=

holding
ISÈO

Iron

La nuova protezione
per cilindro Europeo
installabile su tutte le porte
a difesa della sicurezza

FIAM
serrature



Iron

La nuova protezione
per cilindro Europeo installabile su
tutte le porte a difesa della sicurezza

Exit

x1R

Serratura
elettronica
per porte blindate

FIAM
hi tech



FIAM
hi tech

EXIT è stata progettata e costruita in conformità
alle normative europee UNI EN 1125 ed EN 12209.
Sono attualmente in corso i test
per l'acquisizione del diritto di marcatura CE
(obbligatorio dall'aprile 2003).

La nuova proposta di FIAM
affinché le uscite di sicurezza
siano veramente sicure



Top Exit DGT

La nuova proposta
di FIAM affinché
le uscite di sicurezza
siano veramente sicure

FIAM
hi tech



EXIT DGT è prodotta in due versioni:
con rullo regolabile e con scrocco.
Per quest'ultima sono in corso i test di certificazione
alle normative europee UNI EN 1125 che consentono
l'installazione di TOP EXIT DGT anche su uscite
di emergenza.



Caratteristiche

- Cilindro in ottone nichelato opaco con chiave piatta reversibile in alpacca
- Classe "4" di sicurezza (UNI 9570)
- 17 pistoncini attivi e contropistoncini in acciaio INOX temprato
- 2 + 2 spine in acciaio temprato antitrapano, posizionate verticalmente e sfalsate fra loro, più 2 spine antisfilamento barilotto poste orizzontalmente
- 5 chiavi e carta di proprietà su involucro di protezione
- Elemento ad U in acciaio inox per impedire l'estrazione degli elementi in caso di spezzatura per tentata effrazione
- Ingegno antistrappo (inclinazione 15°)
- Vite di fissaggio cilindro nichelata, M5x76 mm

SCUDO 9000



MODELLO	Ingegno antistrappo	Perni antistrappo verticali	Perni antistrappo orizzontali	Inserto ad U	Protezione duplicazione chiave
MOD. 600	●				
SCUDO 5000	●	●			
U TECH	●	●		●	
SCUDO 9000	●	●	●	●	
SCUDO DCK	●	●	●	●	●

Caratteristiche

- Cilindro di sicurezza nichelato
- Classe "3" di sicurezza (UNI EN 1303)
- 7 pistoncini attivi e contropistoncini in acciaio INOX temprato
- Spine antitrapano in acciaio temprato su ogni lato chiave
- 5 chiavi piatte reversibili con collo allungato resistenti alla torsione
- Ingegno antistrappo (inclinazione 15°)
- Vite di fissaggio cilindro nichelata, M5x76 mm

SCUDO 5000



La Tecnologia Del Serramento

fapim®
Gruppo EUROINVEST

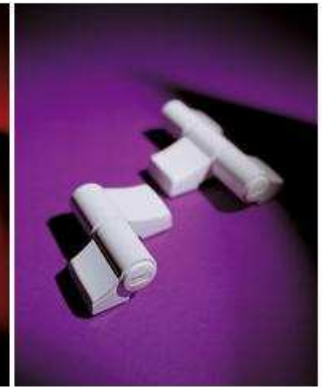

CE 0425
EN 1125:97
+ A1: 2001



MultiComfort *Nasce un nuovo modo di vedere gli accessori per scorrevoli*



Art. 6302



Art. 6317
Maniglia a maniglia Fix
Art. 6316
Maniglia a cassetta
con maniglia



Art. 6314
maniglia di traliccio
Art. 6312
maniglia di traliccio
con maniglia



Finalmente una sicura manovra
Sicurezza ottimale grazie alle aste a 2 e 3 punti per le finestre e porte-finestre. Rapide e facili da installare, rappresentano una **difesa irrinunciabile** contro le effrazioni.

Manuale o automatico, il **blocco serratura universale**, unito alla gamma di maniglie e mascherine, permette un insieme di combinazioni tecniche ed estetiche finora **impossibili**.



Art. 6322

FastLock

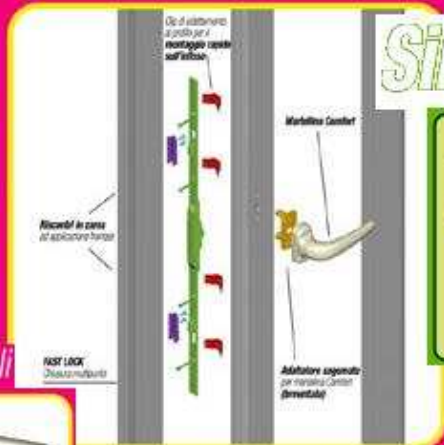

SimplePlus



La velocità di montaggio e la sicurezza per i sistemi scorrevoli

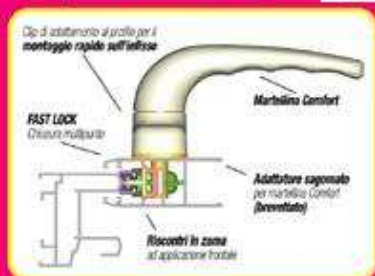
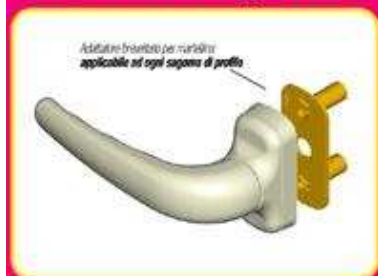

ACCESSORI VARI

GUARNIZIONI STANDARD PER SERRAMENTI IN ALLUMINIO

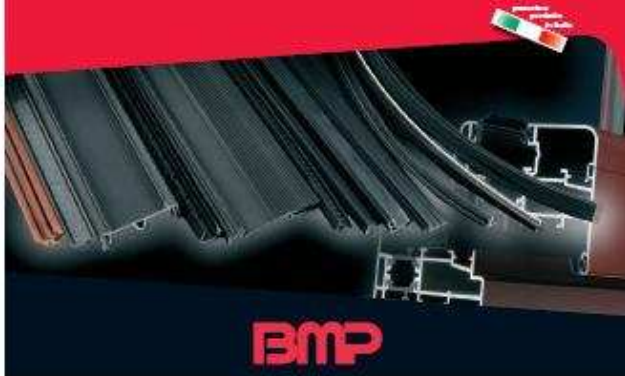

BMP

PER UNA CORRETTA COLLABORAZIONE COL CLIENTE E PERCHÉ IL NOSTRO PRODOTTO POSSA CONTRIBUIRE A MIGLIORARE IL VOSTRO SERRAMENTO

Egregio Serramentista,
è per me importante poterla informare sui quali aspetti legislativi dovrà confrontarsi per una corretta progettazione del suo prodotto:

Legge 10/91 art. 30 Certificazione Energetica degli Edifici
Legge 447/95 disp. 5/12/97 Normativa sull'inquinamento Acustico

Per essendo leggi che interessano l'edificio nel suo complesso, coinvolgeranno anche i costruttori di serramenti ai quali verrà richiesta una prestazione certificata del loro prodotto, in quanto i serramenti rappresentano una superficie rilevante dell'edificio.

Questi i riferimenti di norma:

- UNI EN 1026 prestazione di tenuta all'ARIA
- UNI EN 1027 prestazione di tenuta all'ACQUA
- UNI EN 12211 prestazione di tenuta al VENTO

Altre specifiche verranno altresì valutate per il serramento:

- Livello di ABBATTIMENTO ACUSTICO
- Livello di ABBATTIMENTO DELLA CONDUZIONE TERMICA

In qualità sia di produttore che di Presidente della Commissione Europea per le norme riferite alle guarnizioni, ritengo che questa promessa sia il punto di partenza per impostare una corretta collaborazione con il Cliente.

Ringraziandola per l'attenzione, Le auguro buon lavoro.

Dot. Corrado Bertelli

GUARNIZIONI FERMAVETRO

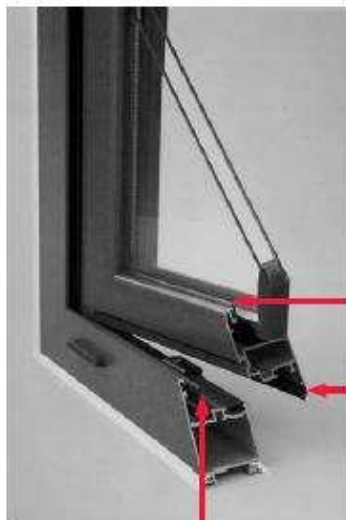

A fermavetro
B battuta centrale
C battuta interna

GUARNIZIONI FERMAVETRO TRASPARENTI Serie F300

- ALCAN
- ALCOA
- ALL.CO
- ALL.CO K WOOD
- EUROPA
- HYDRO

SPAZZOLINI PER SCORREVOLI E ZANZIARIERE



METRA

serie NEW-TEC

PASSERINI

PROFILATI

ASTINE DI COLLEGAMENTO in poliammide

GUARNIZIONI PER PERSIANE

NACO
C 1394* - Guarnizione per lamella

UNIVERSAL 55 - PERLA 70
EL 153*

BMP

GUARNIZIONI STANDARD PER SERRAMENTI IN ALLUMINIO



Accessori Finestre

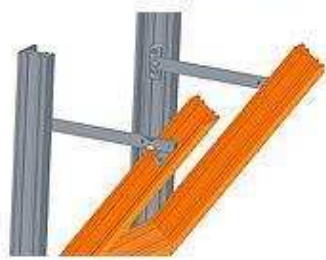

Alluminio: squadrette in acciaio e alluminio per finestre



« Squadrette in alluminio pressofuso

Design: maniglioni per ingressi di prestigio in puro stile italiano



« COLLECTION Comunello Design



Maniglioni in acciaio inox AISI 316L





COVER SYSTEM by 

 **TECNOSTAMP**

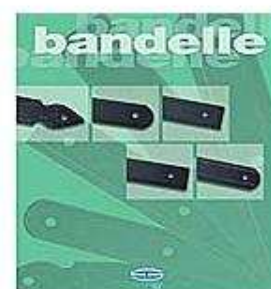

 **TECNOSTAMP**

Finalmente una vera garanzia contro la ruggine. TECNOSTAMP presenta ufficialmente al mercato il nuovo processo protettivo "COVER SYSTEM": un NUOVO trattamento di verniciatura ANTICORROSIONE!

Attestato dalle grandi case automobilistiche, aerospaziali e navali, COVER SYSTEM permette di eliminare DEFINITIVAMENTE la ruggine garantendone la SICUREZZA del prodotto. COVER SYSTEM resiste ai raggi UV, non fa perdere la brillantezza al prodotto e non fa sfarinare la superficie finita. I test in NEBBIA SALINA (prove accelerate agli eventi atmosferici) consentono di arrivare alle 800-900 ORE DI RESISTENZA!

COVER SYSTEM by 

Attestato dalle grandi case automobilistiche, aerospaziali e navali, COVER SYSTEM permette di eliminare DEFINITIVAMENTE la ruggine garantendone la SICUREZZA del prodotto. COVER SYSTEM resiste ai raggi UV, non fa perdere la brillantezza al prodotto e non fa sfarinare la superficie finita. I test in NEBBIA SALINA (prove accelerate agli eventi atmosferici) consentono di arrivare alle 800-900 ORE DI RESISTENZA!

 **Accessori per Scuri in Legno**



Proprietà Hammer srl
Vietata la Riproduzione
Eccentricità: 2,25 mm

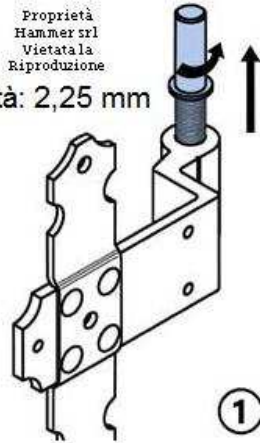

Cardine da interno ambidestro in alluminio estruso con boccola Nylon \varnothing 10 mm e perno eccentrico. Grazie al **fissaggio su mazzetta** non richiede ponteggi per la posa in opera e consente, inoltre, regolazioni in altezza.



Prodotto Brevettato / Patented.

Kit antisfilamento per anta persiana.

Specifico per cardini Hammer.

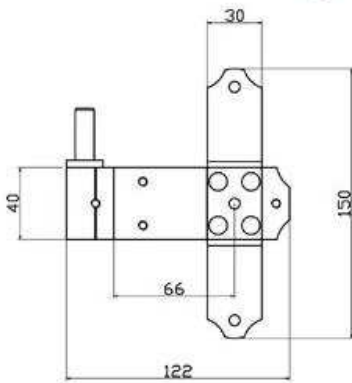

①



Proprietà Hammer srl
Vietata la Riproduzione

Assicura la cerniera al cardine impedendo all'anta di sfilarsi in caso di vento o di sollevamento accidentale.

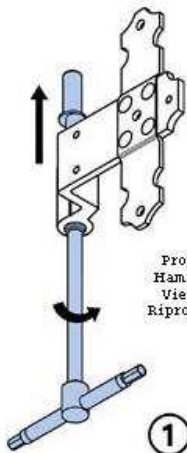

Proprietà Hammer srl
Vietata la Riproduzione

①



DESTRA

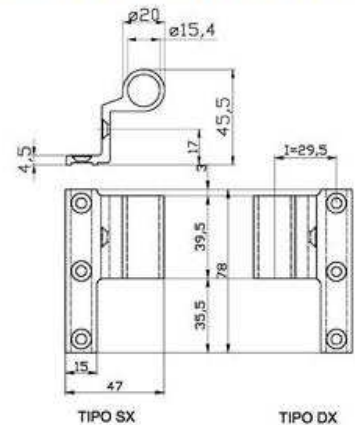

COMPANY WITH QUALITY SYSTEM
CERTIFIED BY DNV
=ISO 9001/2000=



Cerniera da interno a scomparsa destra in alluminio



Automatismi e accessori
GEZE per serramenti.
Qualità certificata ISO 9001

Chiudiporta aerei



TS 5000

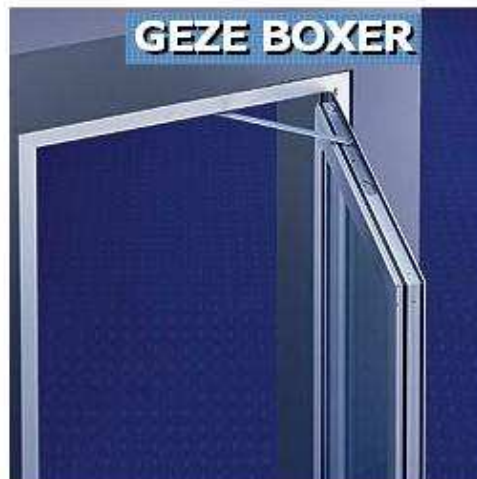

GEZE BOXER

Chiudiporta a pavimento

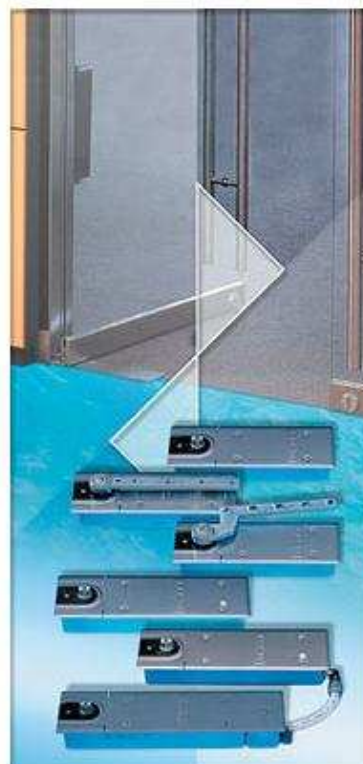

Sistemi per soprafini

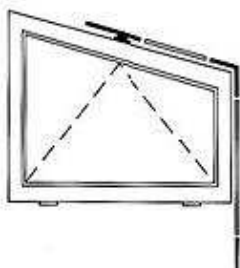
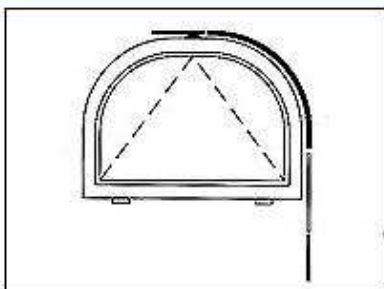



ISEO









Ashley Norton
U.S.A.

Heritage Brass
GREAT BRITAIN



-  Jazz
-  Volo
-  Pegasus
-  Geo
-  Dodo
-  Challenger
-  Gladium
-  Blade
-  Comma

-  S300
-  S350
-  S500
-  S400
-  S450
-  S550
-  Maniglioni
-  Pomoli
-  Accessori

- Finiture**
-  Steel Line
 - 
 - 
 - 
 - 
 - 
 - 
 - 
 - 

automazione serramenti **TQPP**

L30
attuatore a catena
forza di spinta 300 N
corsa max 380 mm

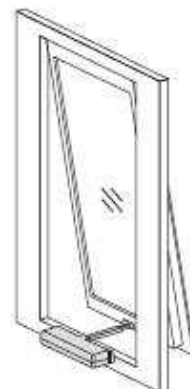

ACR4
attuatore a catena
forza di spinta 350 N
corsa max 400 mm



TQPP
tecnologie del movimento

La Zanzariera

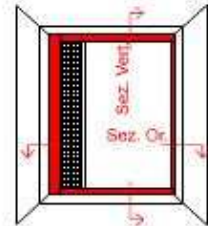
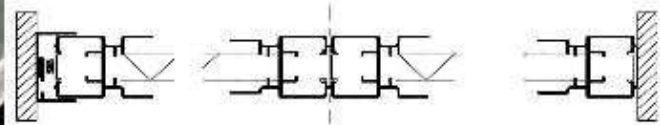
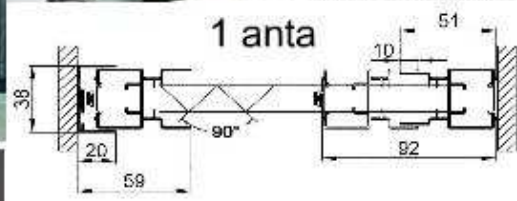

Plissé è una zanzariera per porte - finestre di largo passaggio. L'assenza di barriere a pavimento agevola il transito e le operazioni di pulizia. E' realizzabile a un'anta, due ante con chiusura centrale, due ante a seguire, tre e quattro ante.

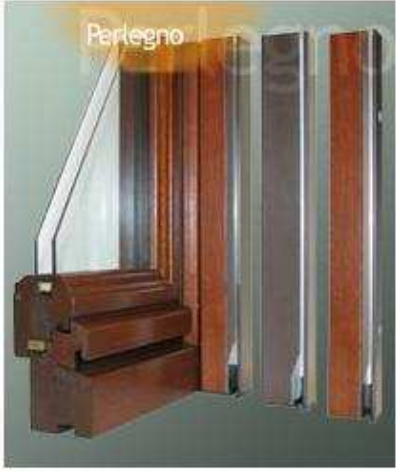

Tutti i modelli della serie "misura" sono caratterizzati dalla rete saldata e rivettata ai bordi. Inoltre consentono l'inserimento di teli oscuranti e filtranti.



Tende a bracci

La tenda a bracci estensibili MB GROUP è disponibile con attacco diretto parete soffitto o montata su barra quadra.

Tende alla veneziana

Le Veneziane MB GROUP vantano la gamma più ampia esistente in tutto il territorio nazionale e rappresentano un prodotto che ci rende leader nel settore della tenda tecnica.

La linea 15/25 è disponibile con varie misure di cassonetto: 27x19, 25x25 e 20x20 (solo per il 15 mm) con una gamma colori di 92 tonalità nei seguenti modelli:

- classic (cassonetto 27x19)
- elegance (cassonetto 25x25)
- privacy (oscurante, senza cave a vista)
- mix (con corde infilate nell'asta di orientamento)
- monocomando ad asta, a corda e a catenella motorizzate
- infravetro con asta flessibile o con cavo con pomolo in metallo

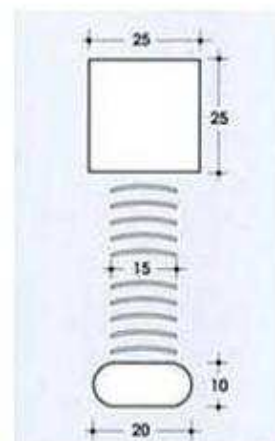

La linea del 35/50 con 26 colori, compresi i nuovi microforati, con possibilità di utilizzare il terilene, il terilnastro o il nastro in pvc per il 50 mm, entrambe motorizzabili o con movimento con monocomando ad asta e solo per il 50 mm con comando rinviato per infravetro.

Inoltre abbiamo le veneziane in legno, splendido complemento di arredo, nella versione da 25 mm o 50 mm e la nuovissima metal wood da 50 mm con cassonetti in legno e lamella microforata da 50 mm.



Tende a rullo

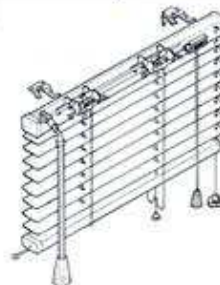



Caratteristiche generali dei prodotti a Catalogo Ninz

La Clientela della Società Ninz potrà scegliere grazie all'ampia offerta di prodotti , quelli di maggior interesse a soddisfare le proprie esigenze questo sia sotto il profilo:

- ✓ **Gamma prodotti** - tra le più complete nell'ambito delle chiusure tagliafuoco riguarda soprattutto porte metalliche-portoni a scorrimento verticale ed orizzontale- porte completamente vetrate realizzate con profili in acciaio anche rivestiti in alluminio, tutti prodotti atti a soddisfare le più diversificate esigenze nell'impiego della riqualificazione di opere edili.
- ✓ **Gamma prodotti** specifici per la rivendita:
 - Porte standards tagliafuoco **UNIVER REVERSIBILI** Rei 60- 120
 - Porte standards multiuso **REVER REVERSIBILI**
 - **REVER REVERSIBILI AD UNA E DUE ANTE**
 - **REVER REVERSIBILI AD UNA E DUE ANTE CON FORI DI AEREAZIONE**
 - **REVER REVERSIBILI AD UNA E DUE ANTE CON TRIPLICE CHIUSURA**
 - **REVER REVERSIBILI AD UNA E DUE ANTE CON FINESTRATURE**
 - UNIVER\REVER REVERSIBILI = SEMPLIFICARE LA GESTIONE DI MAGAZZINO CON L'OPPORTUNITA' DI REALIZZARE COMUNQUE MAGGIORI COMBINAZIONI DI VENDITE
 - UNIVER\REVER REVERSIBILI = POSSIBILITA' DI FISSAGGIO CON ZANCHE O TASSELLI
 - UNIVER\REVER REVERSIBILI = TELAIO ASSEMBLATO CON CERNIERE REGISTRABILI
 - UNIVER\REVER REVERSIBILI = PREDISPOSIZIONI DI SERIE PER EVENTUALE SUCCESSIVA APPLICAZIONE ACCESSORI
 - UNIVER\REVER REVERSIBILI= TANTI ALTRI VANTAGGI E QUINDI UN VERO AFFARE PER IL RIVENDITORE
- ✓ **Economico** - il prodotto Ninz è tra i più competitivi sul mercato
- ✓ **Tecnico**: - prodotti realizzabili anche nelle misure richieste dal Committente; tipologie di prodotti atti ad essere installati su elementi di supporto quali ad es. muratura , cartongesso , strutture metalliche ; anticipo telai per agevolare l'avanzamento delle opere;ricca gamma di accessori ed elementi di finitura ; infinite possibilità di colorazione in tinte Ral;imballi personalizzati su commessa.